

HOLE CLEANING KIT Part#MP-CLEAN-1/2

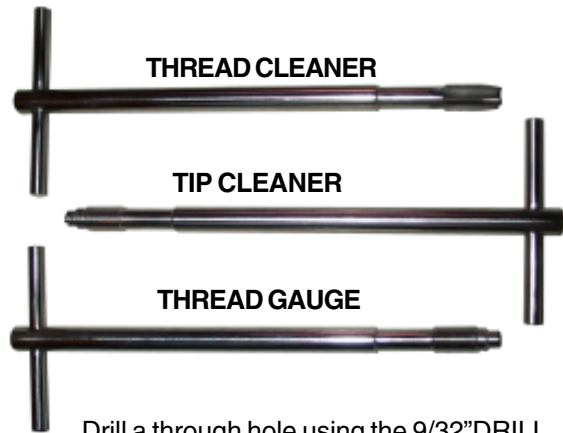

1. Drill a through hole using the 9/32" DRILL
2. Ream the hole using a 5/16" REAMER
3. Using the 29/64" PILOT DRILL, Drill a hole leaving 0.225" of reamed 5/16" D hole untouched - See DWG.
4. Drill using the 17/32" D DRILL to leave 1" of the 29/64" HOLE untouched (If required).
5. Tap hole using the 1/2-20 UNF TAP (not bottoming tap) as far as possible without touching the 45deg seating surface.
6. Tap using 1/2-20 UNF BOTTOMING TAP as far as possible.
7. Examine to ensure 45deg seating surface is untouched. If necessary, clean using 29/64" PILOT DRILL.

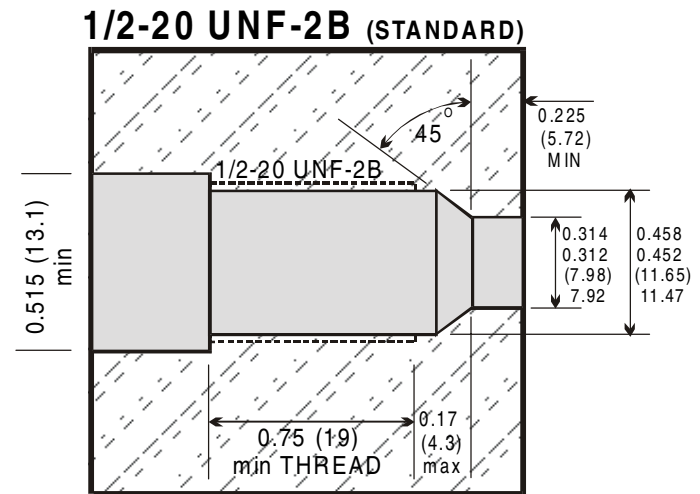

MPI MELT PRESSURE

PH-(800) 817-3486