

ADJUSTABLE BAYONET THERMOCOUPLES & RTD'S

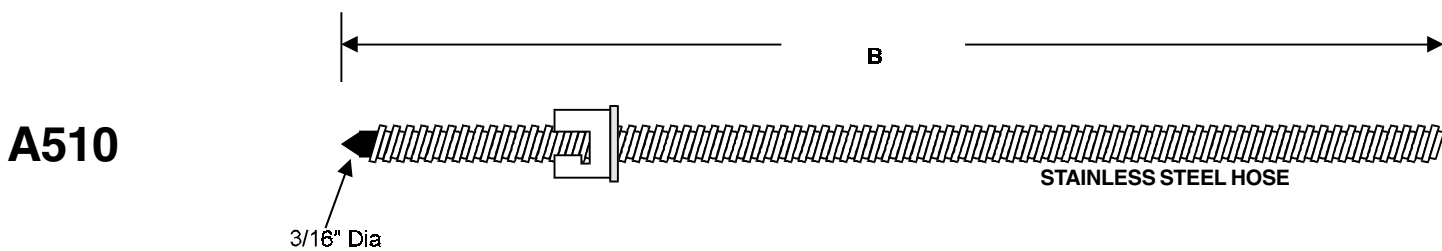

NOZZLE THERMOCOUPLES & RTD'S

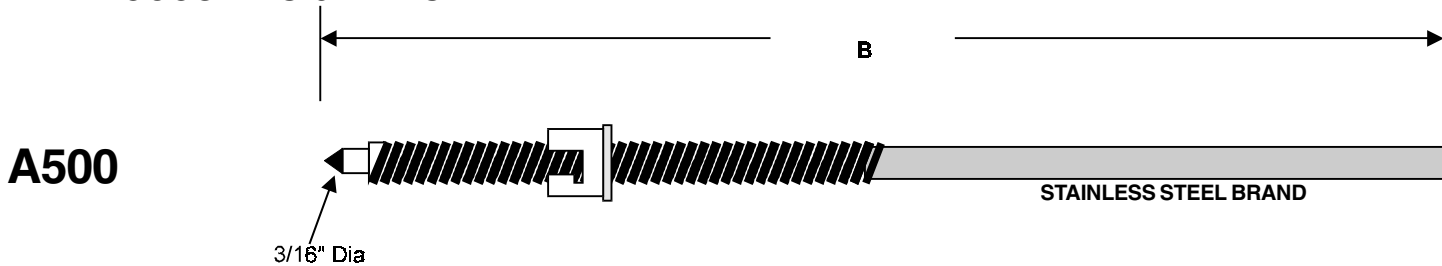
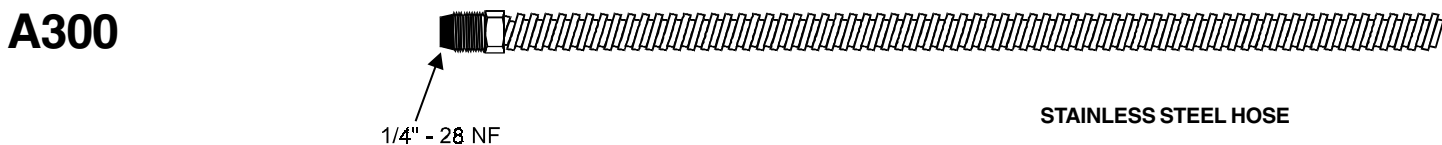
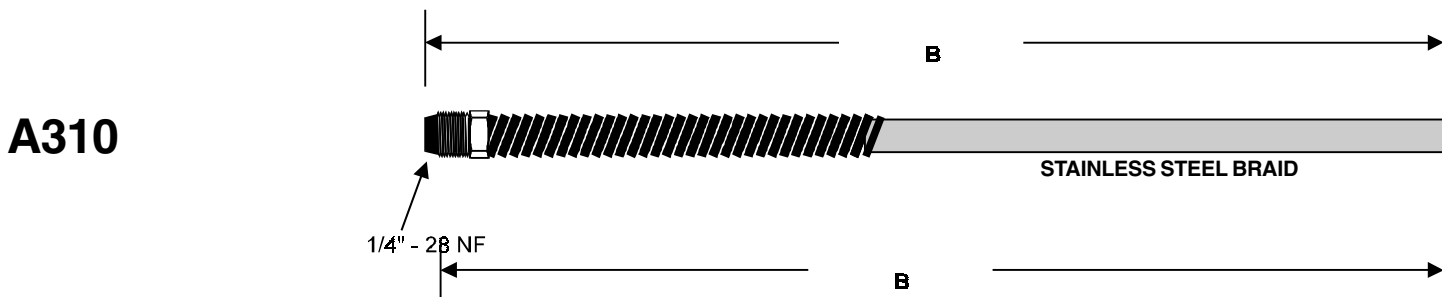

HOW TO ORDER

A500
A510
A310
A300

1	2	3	4
TYPE	"B" (in)	TERMINAL	OPTIONS
J	48	1	U- UNGROUNDED
K	72	2	X- SPECIAL
RTD	96	3	B- 1/8" NPT x 7/8" L BAYONET ADAPTER
	120	4	C- NIST TRACEABLE
	SPECIAL	5	M- METRIC DOUBLE SLOT CAP

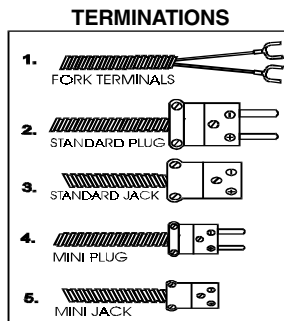

FIXED BAYONET THERMOCOUPLES & RTD'S

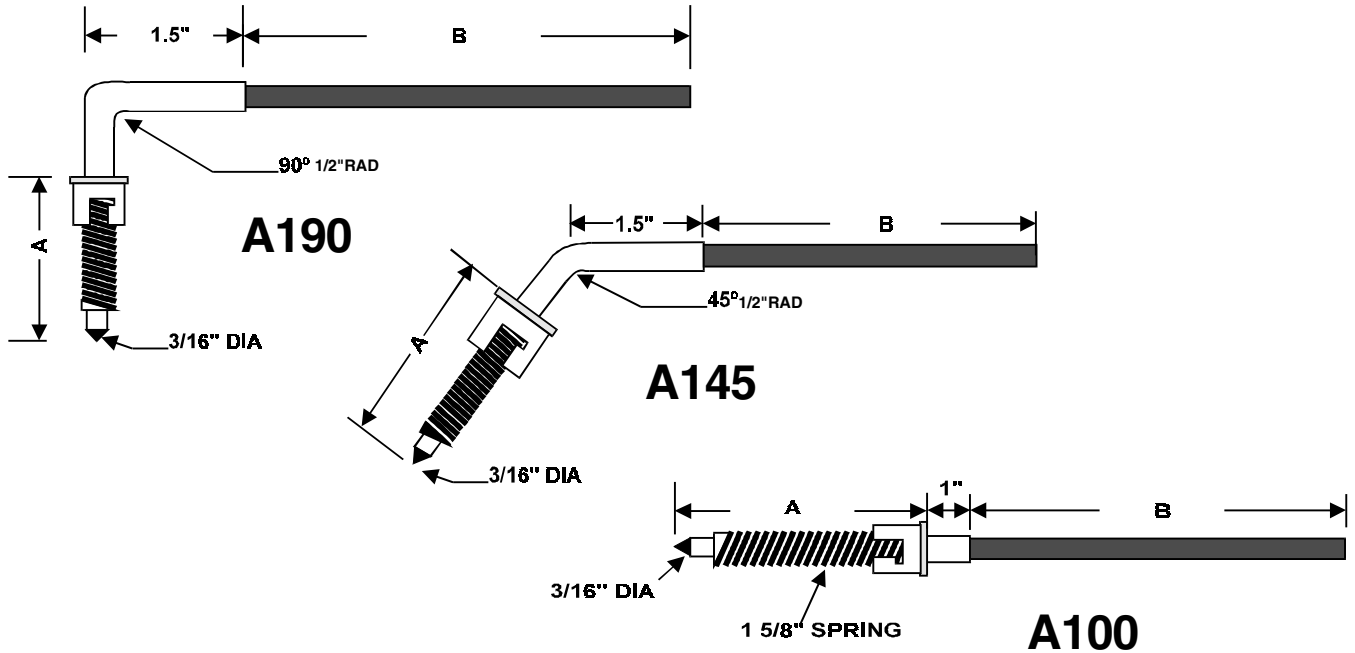

COMPRESSION THERMOCOUPLES & RTD'S

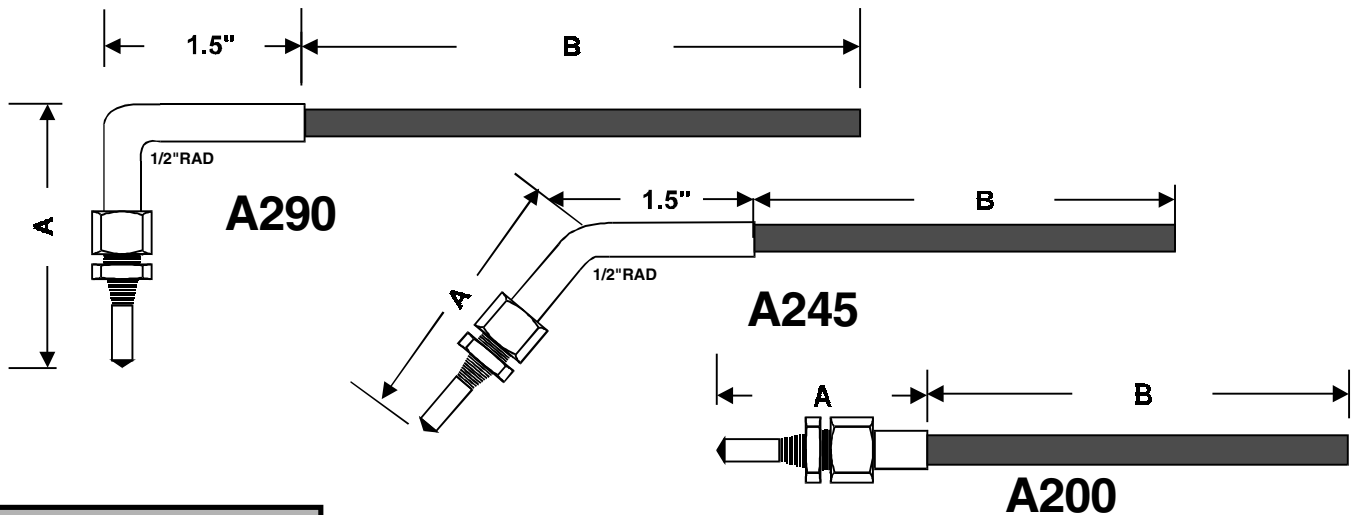

HOW TO ORDER

304 SS STANDARD

A100	<input type="checkbox"/>	<input type="checkbox"/>	<input type="checkbox"/>	<input type="checkbox"/>	<input type="checkbox"/>	<input type="checkbox"/>	<input type="checkbox"/>	<input type="checkbox"/>	<input type="checkbox"/>	<input type="checkbox"/>
A145	<input type="checkbox"/>	<input type="checkbox"/>	<input type="checkbox"/>	<input type="checkbox"/>	<input type="checkbox"/>	<input type="checkbox"/>	<input type="checkbox"/>	<input type="checkbox"/>	<input type="checkbox"/>	<input type="checkbox"/>
A190	<input type="checkbox"/>	<input type="checkbox"/>	<input type="checkbox"/>	<input type="checkbox"/>	<input type="checkbox"/>	<input type="checkbox"/>	<input type="checkbox"/>	<input type="checkbox"/>	<input type="checkbox"/>	<input type="checkbox"/>
	1 TYPE J K T RTD	2 "A" DIA	3 "B" L	4 TERM 1 2 3	5 LEADS F - FIBERGLASS B - STAINLESS BRAID H - STAINLESS HOSE T - TEFLON FS - FIBERGLASS STRANDED	6 OPTIONS U - UNGROUNDED X - SPECIAL B - 1/8" NPT x 7/8" L BAYONET ADAPTOR C - NIST TRACEABLE M - METRIC CAP				
A200	<input type="checkbox"/>	<input type="checkbox"/>	<input type="checkbox"/>	<input type="checkbox"/>	<input type="checkbox"/>	<input type="checkbox"/>	<input type="checkbox"/>	<input type="checkbox"/>	<input type="checkbox"/>	<input type="checkbox"/>
A245	<input type="checkbox"/>	<input type="checkbox"/>	<input type="checkbox"/>	<input type="checkbox"/>	<input type="checkbox"/>	<input type="checkbox"/>	<input type="checkbox"/>	<input type="checkbox"/>	<input type="checkbox"/>	<input type="checkbox"/>
A290	<input type="checkbox"/>	<input type="checkbox"/>	<input type="checkbox"/>	<input type="checkbox"/>	<input type="checkbox"/>	<input type="checkbox"/>	<input type="checkbox"/>	<input type="checkbox"/>	<input type="checkbox"/>	<input type="checkbox"/>
	1 TYPE J K T RTD	2A DIA 1/8" 3/16" 1/4" SPECIAL	2B "A" L	3 "B" L	4 TERM 1 2 3 4 5	5 LEADS F - FIBERGLASS B - STAINLESS BRAID H - STAINLESS HOSE T - TEFLON FS - FIBERGLASS STRANDED P - PVC SOLID PS - PVC STRANDED	6 OPTIONS U - UNGROUNDED X - SPECIAL N - NONE C - NIST TRACEABLE	7 COMPRESSION FITTINGS N - NO FITTING S2 - 1/2" NPT STAINLESS S4 - 1/4" NPT STAINLESS S8 - 1/8" NPT STAINLESS B2 - 1/2" NPT BRASS B4 - 1/4" NPT BRASS B8 - 1/8" NPT BRASS		

SHIM STOCK THERMOCOUPLES

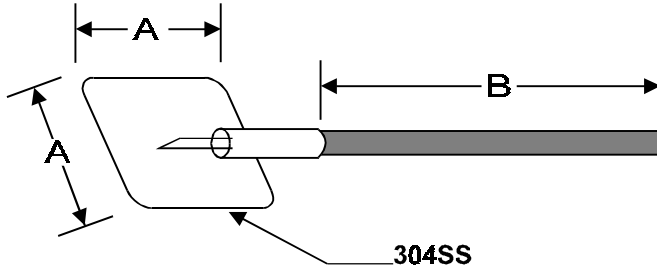

A800

RING TERMINAL THERMOCOUPLE

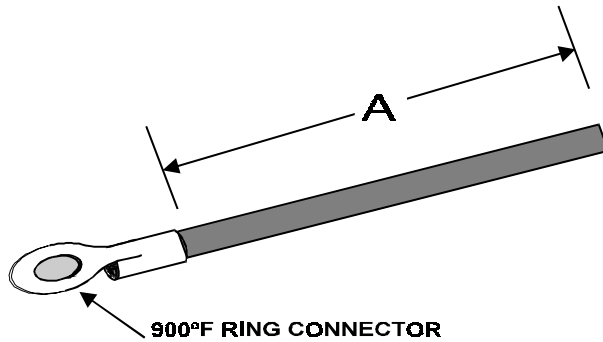

A700

PIPE CLAMP THERMOCOUPLE

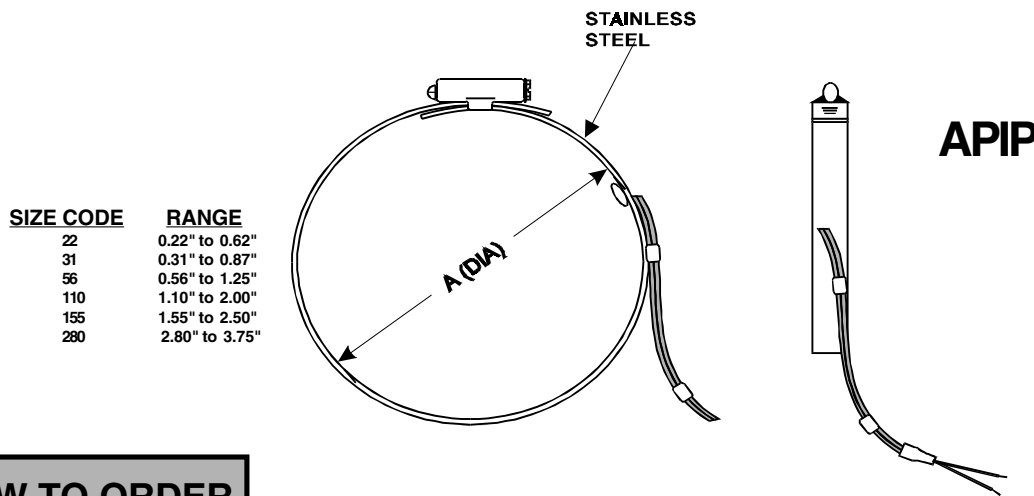

APIP

HOW TO ORDER

A800	□	□	□	□	□	□									
APIP	1	2	3	4	5	6									
	TYPE	"A"	"B"	TERM	LEADS	OPTIONS									
	J			1		U-UNGROUND									
	K			2		X-SPECIAL									
	T			3		C - NIST TRACEABLE									
				4		F - FIXED PIPE CLAMP									
				5											
						F - FIBERGLASS									
						S - FIBERGLASS - STRANDED									
						B - STAINLESS BRAID									
						H - STAINLESS HOSE									
						P - PVC-SOLID									
						PS- PVC STRANDED									

A700	□	□	□	□	□	□									
	1	2	3	4	5	6									
	TYPE	"A"	"B"(in.)	TERM	LEADS	OPTIONS									
	J	#8		1		U-UNGROUND									
	K	#10		2		X-SPECIAL									
	T	1/4"		3		C - NIST CERTIFIED									
				4											
						F - FIBERGLASS									
						S - FIBERGLASS STRANDED									
						B - STAINLESS BRAID									
						H - STAINLESS HOSE									
						P - PVC-SOLID									
						PS-PVC-STRANDED									

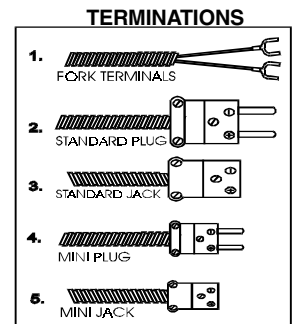

EXTENSION ASSEMBLIES

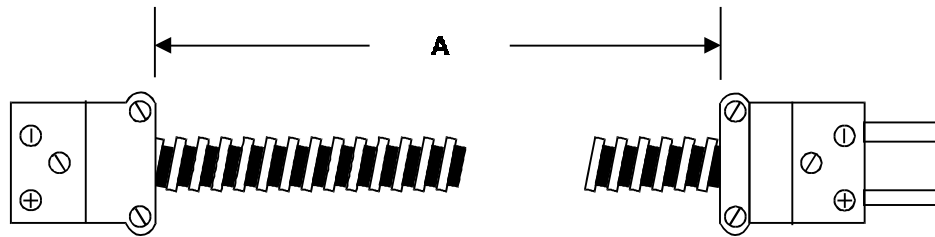

A900

PLASTIC MELT THERMOCOUPLES & RTD'S

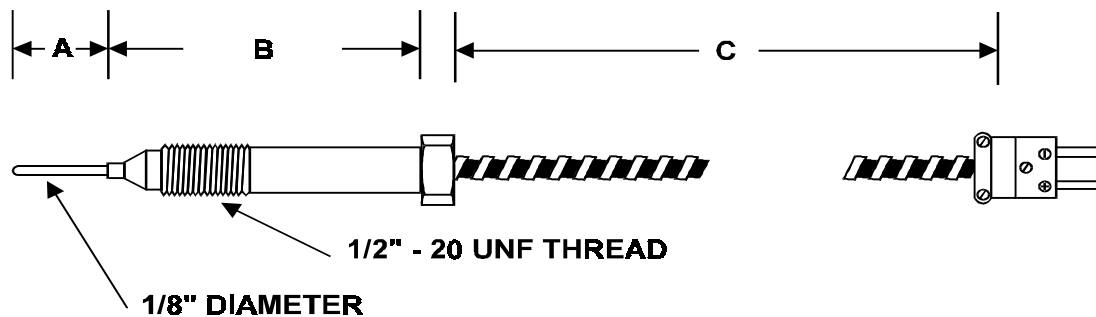

A400

HOW TO ORDER

A900	□	□	□	□	□	A400	□	□	□	□	□	□	□
1	2	3	4	5	1	2	3	4	5	6	7		
TYPE	"A"	LEADS	TERM -1	TERM -2	TYPE	"A"	"B"	"C"	TERM	LEADS	OPTIONS		
J		↓	1	1	J	0"	3"		1	N - NONE	U - UNGROUNDED		
K			2	2	K	1/4"	6"		2	FS - FIBERGLASS	X - SPECIAL		
T			3	3	T	SPECIAL	9"		3	STRANDED	C - NIST TRACEABLE		
RTD			4	4	RTD(400°C)		12"		4	F - FIBERGLASS			
			5	5					5	B - STAINLESS BRAID			
										H - STAINLESS HOSE			
										P - PVC			
										PS - PVC STRANDED			

