

CABLE & CONNECTORS TRANSDUCER / TRANSMITTER



CABLE ASSEMBLIES THERMOCOUPLE / RTD



PART NUMBER

MP-CAB - CONNECTOR	MATERIAL	PROTECTION	LENGTH(ft)
6B - 6PIN Bayonet	P - PVC (105°C)	N - NONE	12 - 12ft (3.6m)
6S - 6PIN Screw	T - Teflon (200°C)	B - 304SS Braid	25 - 25ft (7.6m)
8B - 8PIN Screw	F - Fiberglass (400°C)	H - 303SS Armour	50 - 50ft (15m)
8BC - 8PIN Screw (BC Wiring)			Special

CONNECTORS	MP-6B (6PIN Bayonet)	MP-6S (6PIN Screw)	MP-8S (8PIN Screw)
------------	----------------------	--------------------	--------------------

PART NUMBER

MP-TC - SENSOR	CONNECT-1	CONNECT-2	MATERIAL	LENGTH(ft)
J - T/C J	F - Female Jack	F - Female Jack	B - Fiberglass/SSBraid	12 - 12ft (3.6m)
K - T/C K	M - Male Plug	M - Male Plug	H - Fiberglass/SSHose	25 - 25ft (7.6m)
P - RTD Pt100	S - Strip Leads	S - Strip Leads	T - Teflon (Stranded)	50 - 50ft (15.2m)
	T - Fork Term	T - Fork Term	P - PVC (Stranded)	Special

PRESSURE RUPTURE DISKS

DIMENSIONAL DATA

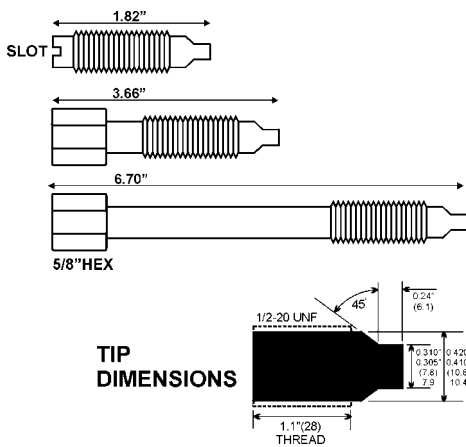

FEATURES

MAX TEMP - 750°F
ACCURACY - 5%
INCONEL DIAPHRAGM

RUPTURE DISK PART NUMBERS

PRESSURE (psi)	DISK LENGTH		
	1.82	3.66	6.70
2500		RUPT-2500-3	RUPT-2500-6
3500	RUPT-3500	RUPT-3500-3	RUPT-3500-6
5500	RUPT-5500	RUPT-5500-3	RUPT-5500-6
6500	RUPT-6500	RUPT-6500-3	RUPT-6500-6
7500	RUPT-7500	RUPT-7500-3	RUPT-7500-6
8500	RUPT-8500	RUPT-8500-3	RUPT-8500-6
9500	RUPT-9500	RUPT-9500-3	RUPT-9500-6
10500	RUPT-10500	RUPT-10500-3	RUPT-10500-6

DIAPHRAGM SELECTION

DIAPHRAGM MATERIAL	APPLICATION
INCONEL (STANDARD)	HIGH TEMP & HIGH ABRASION
TRIPLE WEAR TIP (INCONEL)	HIGH TEMP & HIGH ABRASION 3X LONGER LIFE
HASTELLOY C-276	EXCELLENT CORROSION RESISTANCE BELOW 600°F
TITANIUM NITRIDE	ABRASION RESISTANCE

MOUNTING HOLE DETAILS

1/2-20 UNF-2B (STANDARD)

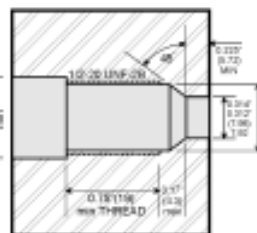

M18 x 1.5

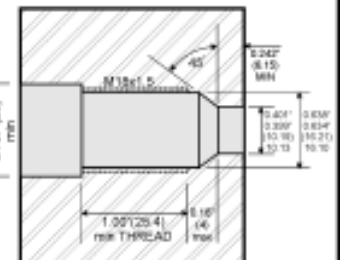

6 PIN BAYONET

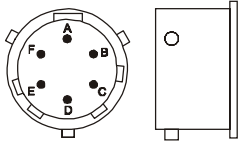

LEAD	COLOR	6 PIN
SIGNAL+	RED	A
SIGNAL-	BLACK	B
EXCITATION+	WHITE	C
EXCITATION-	GREEN	D
CALIBRATION	BLUE	E
CALIBRATION	ORANGE	F

6 PIN SCREW

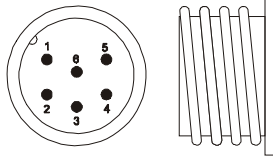
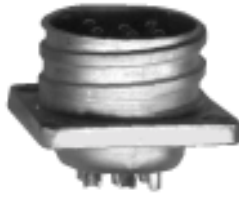

LEAD	COLOR	6 PIN
EXCITATION+	WHITE	1
EXCITATION-	GREEN	2
SIGNAL-	BLACK	3
SIGNAL+	RED	4
NOT USED		5
NOT USED		6

8 PIN SCREW

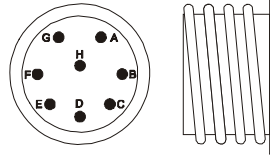

LEAD	COLOR	8 PIN
EXCITATION+	WHITE	A
SIGNAL+	RED	B
EXCITATION-	GREEN	C
SIGNAL-	BLACK	D
CALIBRATION	BLUE	E
CALIBRATION	ORANGE	F
NOT USED		G
NOT USED		H

8 PIN SCREW (Barber Colman)

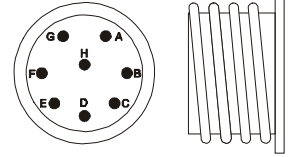

LEAD	COLOR	8 PIN
EXCITATION+	WHITE	A
SIGNAL+	RED	B
SIGNAL-	BLACK	C
EXCITATION-	GREEN	D
CALIBRATION	BLUE	E
CALIBRATION	BROWN	F
NOT USED		G
NOT USED		H

HOLE CLEANING KIT



PART # MP-CLEAN-1/2

Kit is used to clean transducer hole before insertion to prevent diaphragm damage.

HOLE CUTTING KIT

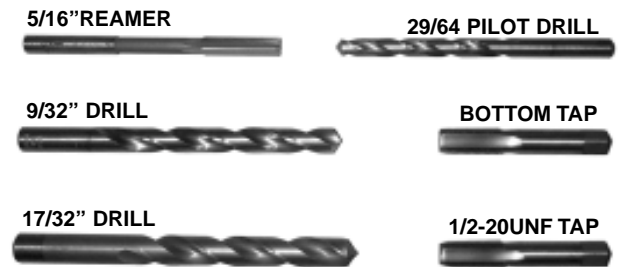

PART # MP-CUT-1/2

All the Drills, Reamers and Taps required to drill a proper hole for standard transducers (1/2-20UNF).

MOUNTING BRACKET

PART # MP-MOUNTB

FOR ALL FLEX STEM
TRANSDUCERS AND GAUGES

